



SHDTU-05is

G.SHDSL.bis Ethernetmodem

Hardware-Manual



AddSecure GmbH

Breite Straße 10
D-40670 Meerbusch
Phone: +49 (0)2159/693 75-0
Fax: +49 (0)2159/922 430 0
E-mail: info.digicomm@addsecure.com

Document Revision: 15-01

For further information regarding our products please visit us at www.addsecure.de

Copyright © 2024 AddSecure GmbH

This document is protected by copyright.

All rights, including translation, reprinting and reproduction using photomechanical or electronic systems, reserved.

Registered trademarks, common names, etc., are not reported in the text. The absence of such indications does not mean that it is a free name in terms of trademark and trademark law.

Legal information

The contents of this document are provided “as is”. Except as required by applicable law, no warranties of any kind, either express or implied, including, but not limited to, the implied warranties of merchantability and fitness for a particular purpose, are made in relation to the accuracy and reliability or contents of this document. AddSecure reserves the right to revise this document or withdraw it at any time without prior notice.

Under no circumstances shall AddSecure be responsible for any loss of data or income or any special, incidental, and consequential or indirect damages howsoever caused.

More information about AddSecure can be found at the following Internet address:

<http://www.addsecure.de>

Content

1.	Safety.....	4
2.	Introduction.....	5
2.1	Descriptions.....	5
2.2	Features.....	5
2.3	Specifications.....	6
2.4	Connections.....	10
2.4.1	Star-connection Point-to-Point	10
3.	Details.....	11
3.1	Front Panel.....	11
3.1.1	LED indicators.....	12
3.1.2	LAN Port.....	12
3.1.2	LAN Port.....	13
3.1.3	WAN Port	13
3.1.4	Console Port.....	15
3.1.5	Reset button.....	15
3.2	Screw contacts.....	16
3.2.1	Power connection.....	16
3.2.2	WAN-Port.....	17
3.2.3	Alarm.....	19
3.3	Assembly.....	20
4	Configuration.....	21
4.1	Configuration methods.....	21
4.2	Preparation.....	21
4.3	Web configuration (HTTP / HTTPS).....	22
4.3.1	Login via Web Browser.....	22
4.4	Serial Console configuration.....	24
4.5	Telnet / SSH configuration.....	25

1. Safety

Before installation:

Read this manual completely and gather all information on the unit. Make sure that you understand it fully. Check that your application does not exceed the safe operating specifications for this unit.

This unit should only be installed by qualified personnel.

This unit must be properly connected to the installation protective ground for safety and functional reasons. This unit should be built-in to an apparatus cabinet, or similar, where access is restricted to service personnel only.

The power supply wiring must be sufficiently fused, and if necessary it must be possible to disconnect manually from the power supply. Ensure compliance to national installation regulations.

This unit uses convection cooling. To avoid obstructing the airflow around the unit, follow the spacing recommendations.

Before mounting, using or removing this unit:

Prevent access to hazardous voltage by disconnecting the unit from power supply.

Warning! Do not open connected unit. Hazardous voltage may occur within this unit when connected to power supply.

Care recommendations

Follow the care recommendations below to maintain full operation of unit and to fulfil the warranty obligations.

This unit must not be operating with removed covers or lids.

Do not attempt to disassemble the unit. There are no user serviceable parts inside.

Do not drop, knock or shake the unit, rough handling above the specification may cause damage to internal circuit boards.

Do not use harsh chemicals, cleaning solvents or strong detergents to clean the unit.

Do not paint the unit. Paint can clog the unit and prevent proper operation.

Do not expose the unit to any kind of liquids (rain, beverages, etc). The unit is not waterproof.

Keep the unit within the specified humidity levels.

Do not use or store the unit in dusty, dirty areas, connectors as well as other mechanical part may be damaged.

If the unit is not working properly, contact the place of purchase, nearest AddSecure distributor office or AddSecure Tech support.

A readily accessible disconnect device shall be incorporated external to the equipment.

This unit may have hot surfaces when used in high ambient temperature.

2. Introduction

2.1 Descriptions

SHDTU-05is G.SHDSL.bis Ethernetmodem / VPN Router is a high performance 4-port Security Gateway providing Internet access and LAN-to-LAN application over existing copper line for small/medium office and industrial applications. Complying with the latest G.SHDSL.bis technology, ITU-T G.991.2 (2004) standard, SHDTU-05is offer data transmission rates of 15,296 Mbps in 2-wire mode.

SHDTU-05is G.SHDSL.bis Ethernetmodem / VPN Router is integrated high-end Bridging/Routing capabilities with advanced functions of Multi-DMZ, Virtual Server mapping and VPN pass-through. Because of rapid growth of network, virtual LAN has become one of the major new areas in internetworking industry. ADDSECURE SHDTU-05is support port-based VLAN and IEEE 802.1q VLAN over ATM/EFM network.

With always on connection that DSL features, SHDTU-05is VPN routers provide advanced firewall with Stateful Packet Inspection (SPI) and Denial of Service (DoS) protection, serving as a powerful firewall to protect from outside intruders of secure connection. It also supports IP precedence to classify and prioritize types of IP traffic. In additional, its VPN feature supports data transmission over the Internet by data encryption/decryption between two sites. VPNs feature allows replacing a private leased line to minimize the expense among global inter-connection.

Not only the much higher bandwidth than convention symmetric digital subscriber loop, SHDTU-05is also provide the network administrators tool of Quality of Service (QoS) to allocate network resources effectively. By classify the priority of services, the functions of bandwidth management increases efficiency and productivity on specific demands such as VoIP, video streaming or video-conferencing to guarantee all the application get the deserved service quality.

2.2 Features

- Easy configuration and management with password control for various application environments
- Efficient IP routing and transparent learning bridge to support Internet broadband services
- Virtual LANs (VLANs) offer significant benefit in terms of efficient use of bandwidth, flexibility, performance and security
- VPN for safeguarded connections
- Built-in advanced SPI firewall
- IP precedence to partition the traffic into multiple classes of service
- Four 10/100M Base-T Auto-sensing, Auto-negotiation and Auto-MDI/MDIX switching port for flexible local area network connectivity
- Fully ATM protocol stack implementation over SHDSL.bis
- PPPoA and PPPoE support user authentication with PAP/CHAP/MS-CHAP/MS-CHAPv2
- SNMP management with SNMPv1/v2c/v3 agent and MIB II

2.3 Specifications

WAN Port:

- SHDSLbis: ITU-T G.991.2 (2004) Annex A/B/F/G supported
- Encoding scheme: TC-PAM 4/8/16/32/64/128
- Data Rate: N x 64kbps (N= 1 - 239, 64-30592 kbit/s)
- Impedance: 135 ohms

LAN Port:

- 1-Port 10/100 Base Tx
- Auto-negotiation for 10/100Base-TX and Half/Full Duplex
- Auto-MDIX

LED:

- Power (Green)
- WAN LINK/ACT(Green)
- LAN (Port 1~port 4) LINK/ACT (Green)
- ALARM (Red)

Bridging and VLAN:

- IEEE 802.1D Transparent Learning Bridge
- IEEE 802.1Q and Port Based VLAN + Q in Q
- Spanning Tree Protocol (STP) (RSTP) (MSTP)
- Up to 2K Mac Address

Routing:

- Static routing and RIP v1/v2(RFC 1058/2453) + OSPF
- NAT/PAT (RFC1631)
- NAT Application Level Gateways
- Skype/MSN/Yahoo Messenger (RFC2933)
- VoIP(SIP) pass through
- VPN PPTP/L2TP pass through
- Virtual Server

Network Protocol:

- IPv4 (ARP/RARP, TCP/UDP,ICMP)
- DHCP Client/Server, Relay
- DNS Relay/Proxy, Dynamic DNS(DDNS)
- IGMP v1/v2/v3, IGMP Proxy, IGMP Snooping
- SNTP and UPnP

ATM:

- 12 PVCs
- OAM F4/F5 Loopback
- AAL5
- VC Multiplexing and SNAP/LLC
- Ethernet over ATM (RFC 2684/RFC1483)
- Multiple protocol over ATM AAL5(MPOA, REF1483/2684)
- PPP over ATM (RFC 2364)
- Classic IP over ATM (RFC 1577)
- QoS(UBR/CBR/VBR/VBR-RT)

EFM:

- Support EFM OAM complying IEEE 802.3a
- EFM bonding (IEEE 802.3ah PAF)
- PPP
- PPPoE
- PAP/CHAP/MS-CHAP/MS-CHAPv2
- Configurable timer to auto-reconnect,
- Configurable Idle times for timeout

QoS:

- 802.1P Tag
- IPv4 ToS/DiffServ
- CoS
- Class-based Prioritization
- Class-based Traffic Shaping
- Class-based DSCP Mark
- Up to 8 priority queues
- IP Precedence Alternation

VPN:

- Plug and Play
- IPSec (RFC2411) up to 4 Tunnels
- DES/3DES/AES
- MD5/SHA-1
- IKE/Manual Key
- ISAKMP (RFC 2407/2408/4306)
- IKE v1 (RFC 2409/4109)
- PSK
- L2TP/PPTP

Firewall:

- SPI (Stateful Packet Inspection)
- Intrusion Detection/DoS (Denial of Service)
- DMZ
- Content Filtering
- URL Blocking
- Packet Filtering/Access Control List (ACL)

Management:

- Web and Telnet management via LAN ports
- CLI via serial console port
- Support SSH (RFC4250/4251/4252/4253/4254/4255/4256)
- SNMP v1/v2c/v3 (RFC 1157/1901//1905)
- MIB II (RFC 1213/1493)
- Syslog with Remote Logging support
- Firmware Upgrade via TFTP
- Configuration Data Import/Export
- Multiple Levels of Administration Privilege
- Support TR-069 WAN management protocol
- Alarm Contacts for Power + WAN failure configurable WEB GUI
- Email

Physical / Electrical:

- Mechanical : IP20 industrial case for DIN rail mounting
- Dimensions: 4x 17.5 x 13.5 cm (WxHxD)
- Redundant 2x 12-72 VDC (10-75 VDC absolute)
- Power Consumption: <5 watt
- Temperature: -20 to +70°C
- Humidity: 0% to 95%RH (non-condensing)

2.4 Connections

2.4.1 Star-connection Point-to-Point

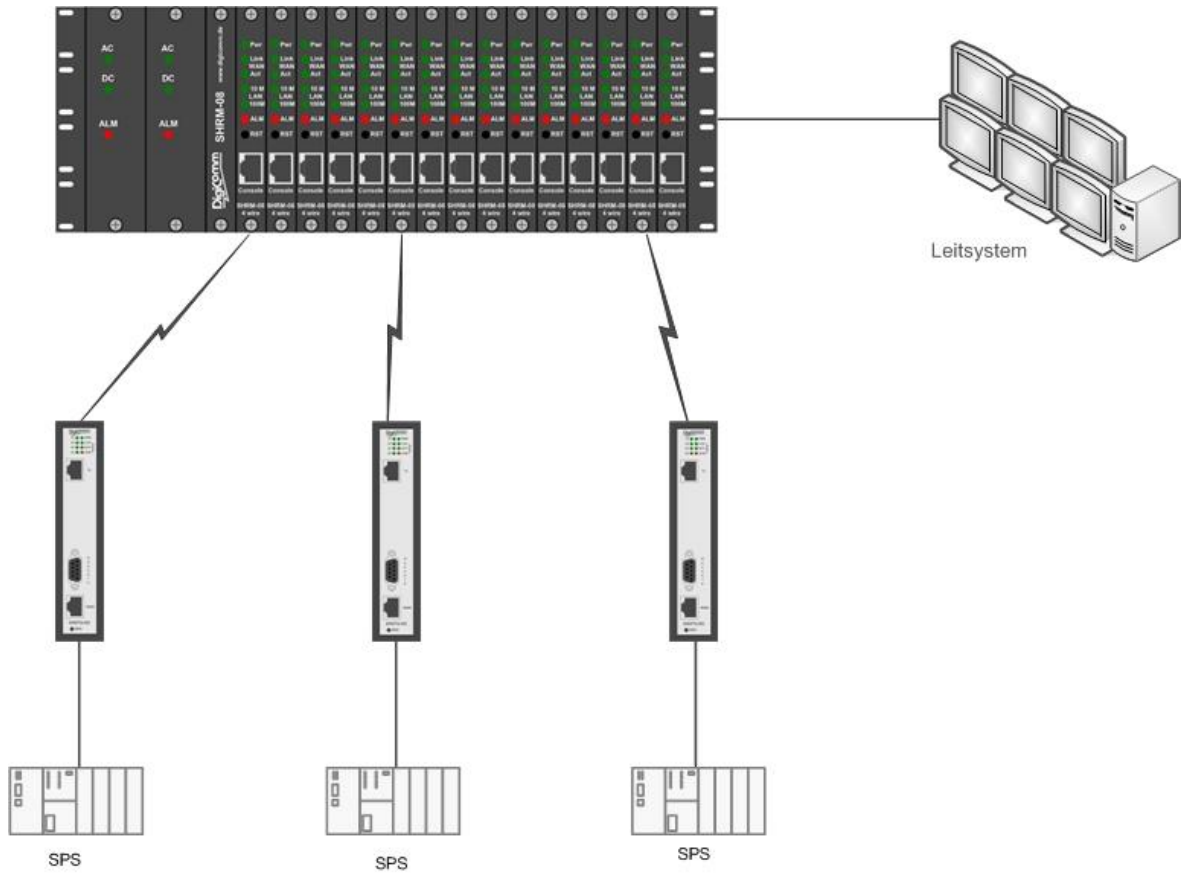

3. Details

3.1 Front Panel

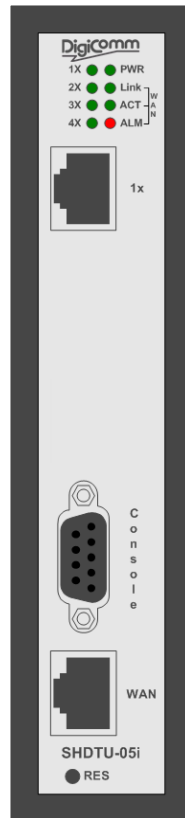

Connector	Description
Console	RJ-45 for system configuration and maintenance
WAN	RJ-45 for WAN connection
RES	Reset button for reboot or load factory default
LAN (1x)	10/100BaseT auto-sensing and auto-MDIX for LAN port (RJ-45)

3.1.1 LED indicators

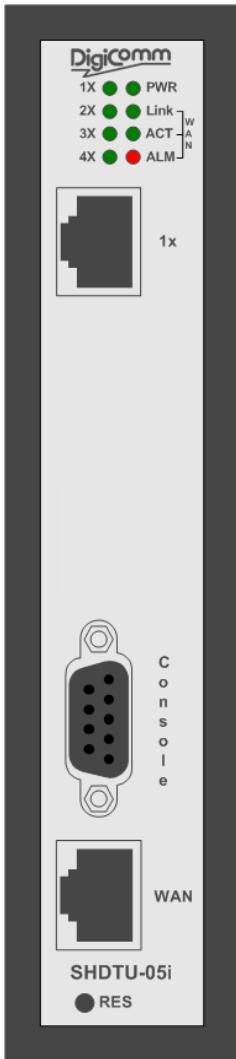

LEDs	Active	Description
PWR	On	The power adaptor is connected to this device
DSL	LINK	SHDSL.bis line connection is established
	ACT	SHDSL.bis line handshake Transmit or received data over SHDSL.bis link
LAN	1X	Ethernet cable is connected to LAN 1
		Transmit or received data over LAN 1
ALM	On	All SHDSL.bis line connections are dropped
	Off	No Alarm

3.1.2 LAN Port

The VPN Router has one LAN port. The port is auto-negotiating and auto-crossover.

In 10/100Mbps fast Ethernet, the speed can be 10Mbps or 100Mbps and the duplex mode can be half duplex or duplex.

The auto-negotiating port can detect and adjust to the optimum Ethernet speed (10/100 Mbps) and duplex mode (full duplex or half duplex) of the connected device. The auto-crossover (auto-MDI/MDI-X) ports automatically works with a straight-through or crossover Ethernet cable.

3.1.3 WAN Port

The VPN Router have one port for WAN port connection, this is a G.SHDSL .Bis interface. The pin assignments for SHDSL line cable are:

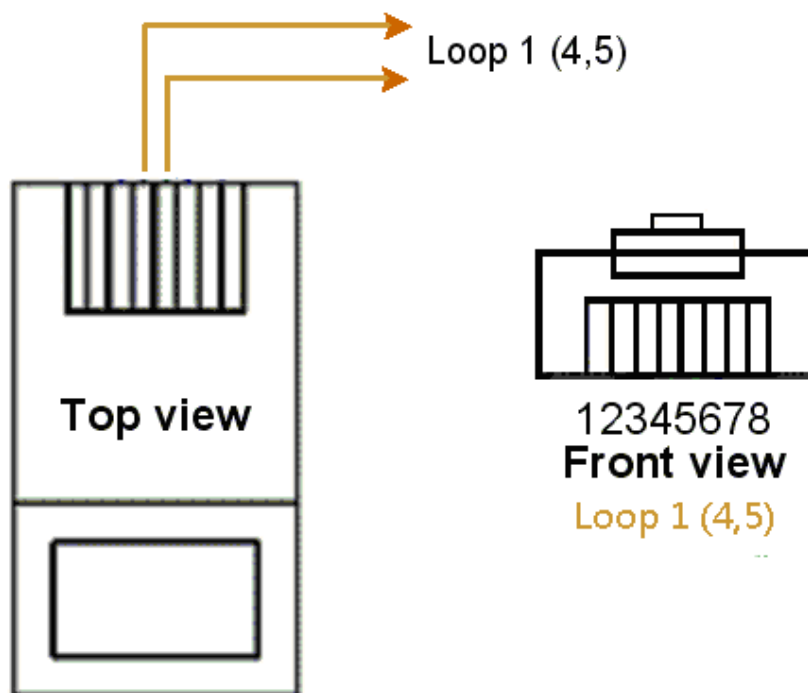

SHDTU-05is				
2-wire mode	Loop1 (4,5)			

For test on point to point connection purpose, you can use the Straight-Through Ethernet Cable for SHDSL.bis link as the following.

T-568A Straight-Through Ethernet Cable

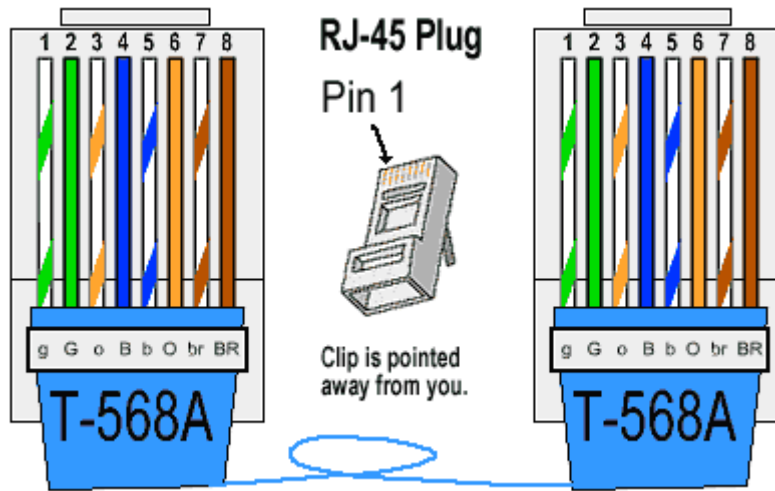

T-568B Straight-Through Ethernet Cable

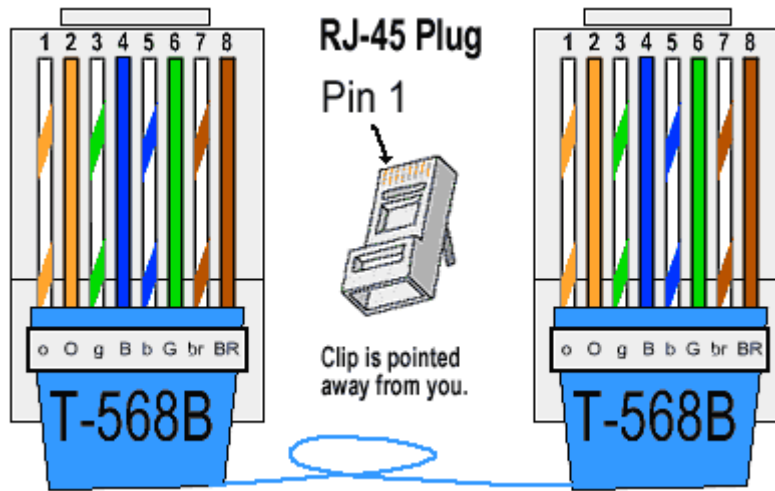

3.1.4 Console Port

Connect the RJ-45 jack of the console cable to the console port of the VPN Router.

Connect the DB-9 female end to a serial port (COM1, COM2 or other COM port) of your computer.

The wiring diagram of the console cable is as follows

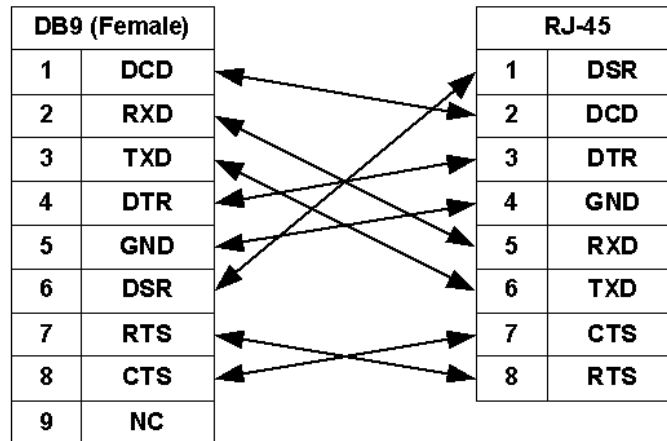

The pin assignment of RJ-45 modular jack on the Console cable:

Pin Number	Abbrev.	Description	Figure
1	DSR	DCE ready	<p>Top View</p> <p>Front View</p>
2	DCD	Received Line Signal Detector	
3	DTR	DTE ready	
4	GND	Signal Ground	
5	RXD	Received Data	
6	TXD	Transmitted Data	
7	CTS	Clear to Send	
8	RTS	Request to Send	

3.1.5 Reset button

The reset button can be used only in one of two ways.

- (1) Press the Reset Button for two second will cause system reboot.
- (2) Pressing the Reset Button for eight seconds will cause the product loading the factory default setting and losing all of your configuration. When you want to change its configuration but forget the user name or password, or if the product is having problems connecting to the Internet and you want to configure it again clearing all configurations, press the Reset Button for eight seconds with a paper clip or sharp pencil.

3.2 Screw contacts

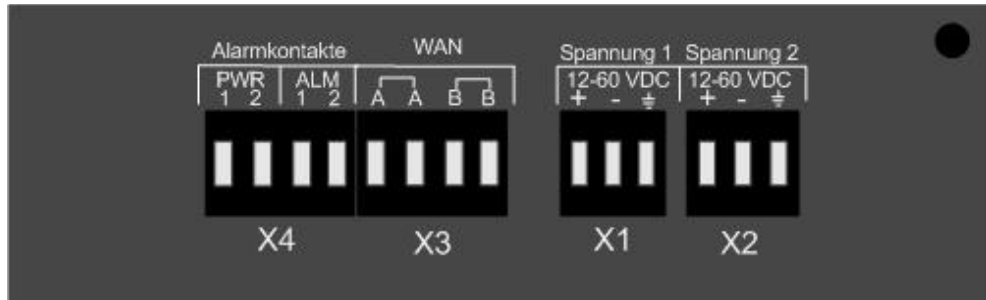

Connector	Description
X1	Voltage 1 12-72 VDC Screw contacts to Power Supply (10-75 VDC absolute)
X2	Voltage 2 12-72 VDC Screw contacts to Power Supply (10-75 VDC absolute)
X3	WAN A/B Screw contacts for WAN 1/2 (channel A/B)
X4	Alarmsignal Screw contacts for power and WAN failiture alarms PWR: Power Fault WAN : Line/DSC Fault (programmable) PWR Alarm contacts opens when Power Fault WAN Alarm contacts close when Link Fault

3.2.1 Power connection

Connect the SHDTU-05is to a power source using the screw connectors at the bottom using current voltages from 12V to 72V DC

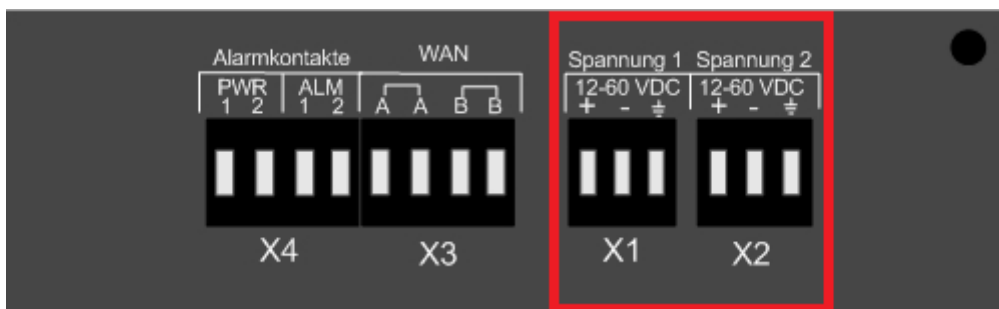

This unit has a redundant power supply. This means i.e. you can have 24VDC on screw connector PWR-1 and 48VDC on PWR-2. If one of the power sources fails, the other one will immediately take over.

CAUTION: Providing the SHDTU-05is with a voltage higher than 75 VDC could resolve in damage board components.

3.2.2 WAN-Port

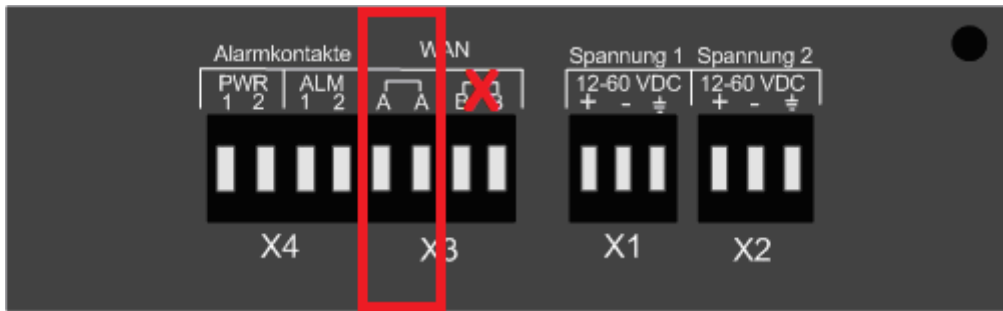

CAUTION: The WAN connectors B/B are not in use.

Point to point Application:

This is an example for a link application, with SHDTU-05is as central and SHDTU-05is as remote station. The following pictures show you how to connect the SHDTUs. Note that Channel B is not available in two wire units.

Network Map

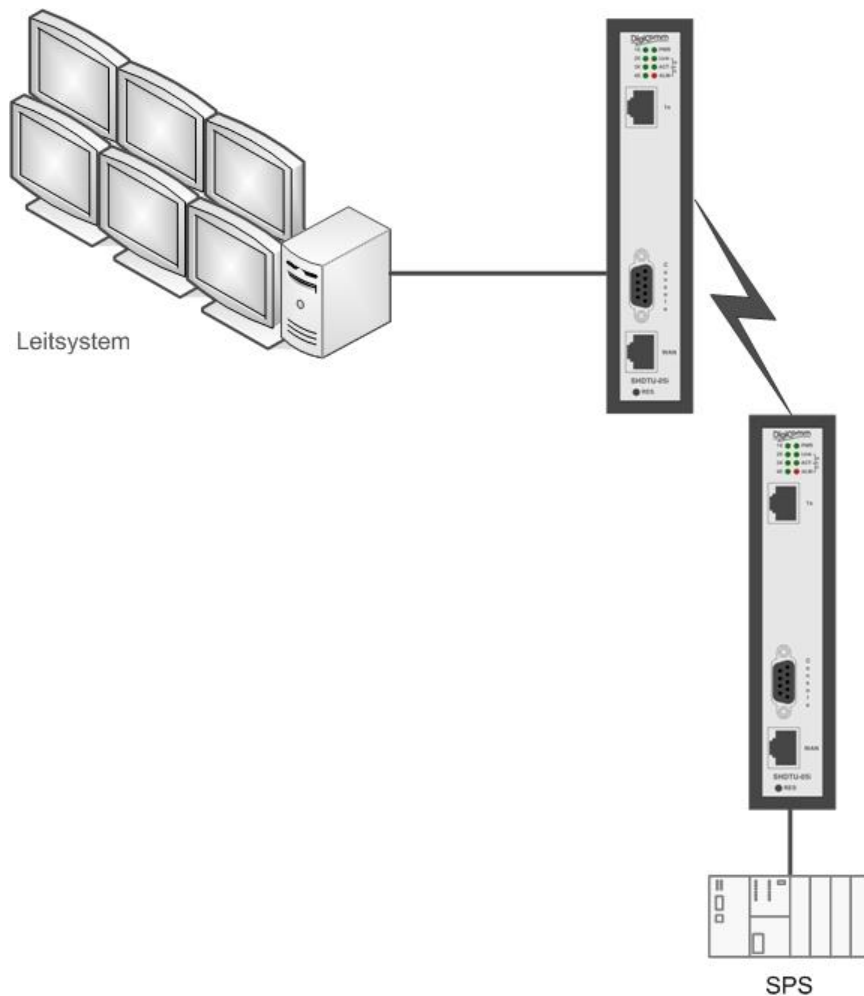

Detail Map

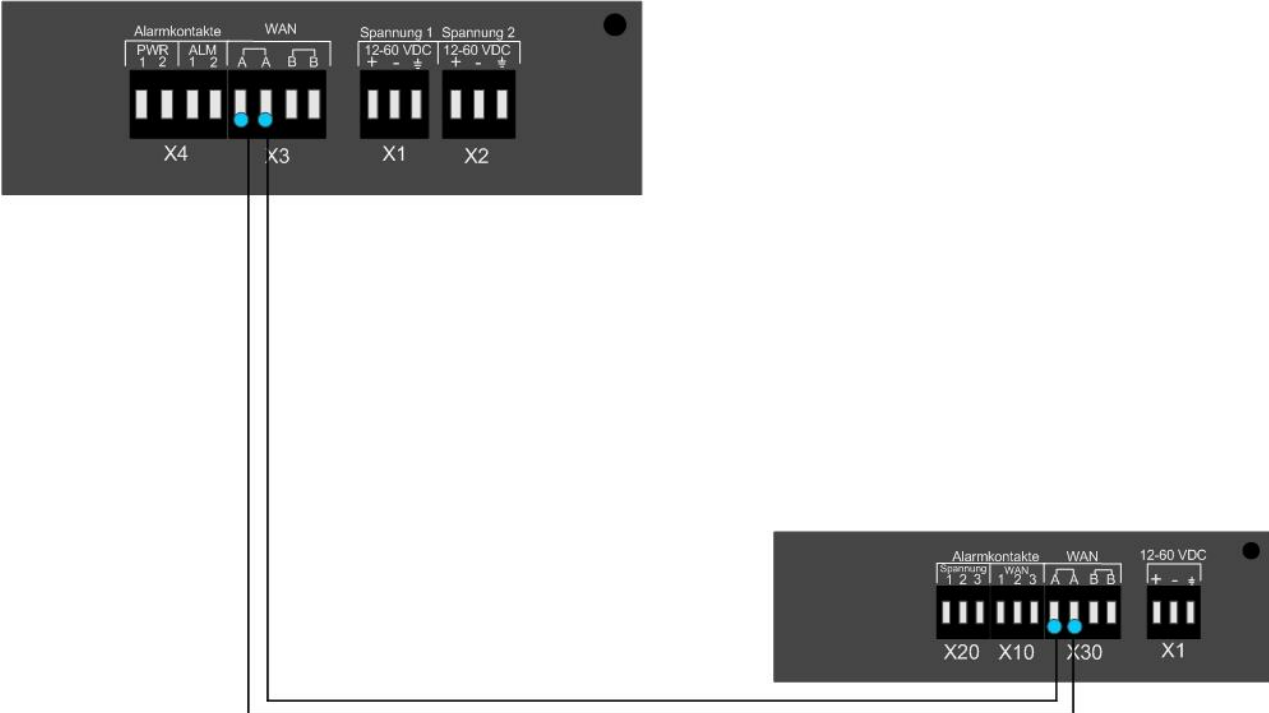

3.2.3 Alarm

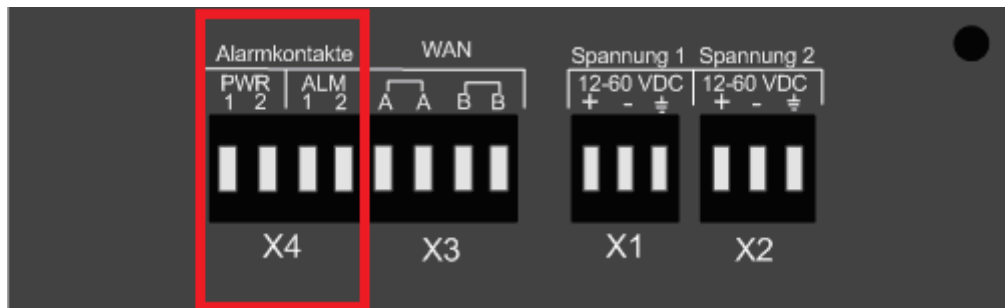

The Alarm contacts are used by connecting an electric circuit to the screw connector if an alarm is engaged the power (PWR) alarm relays is opened and the WAN (ALM) relays is closed.

CAUTION: Using the alarm relays contacts with more than the regular 30V DC and 2A could cause damage to the board components!

3.3 Assembly

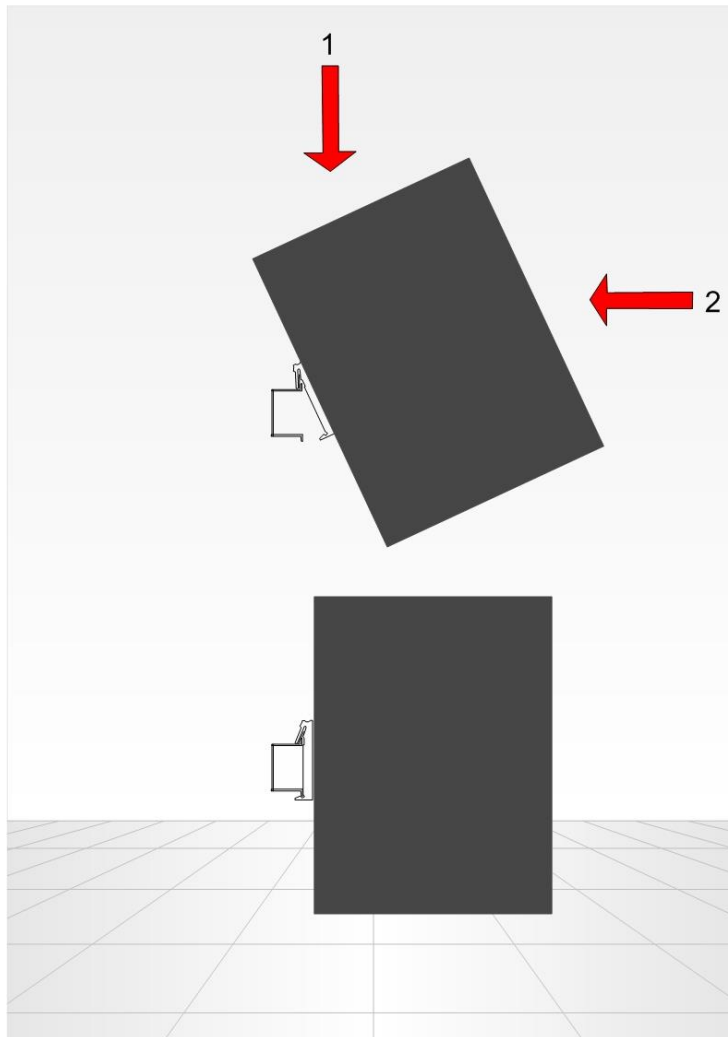

This unit should be mounted on 35 mm DIN-rail, which is horizontally mounted inside an apparatus cabinet, or similar. Snap on mounting, see figure. To cool this unit convection cooling is used. To avoid obstructing the airflow around the unit, use the following spacing rules. Minimum spacing 25mm (1.0 inch) above / below and 10mm (0.4 inches)

Left / right the unit. Spacing is recommended for the use of unit in full operating temperature range and service life.

4 Configuration

4.1 Configuration methods

There are three methods to configure the VPN Router: serial console, Telnet/SSH and Web Browser. Users have to choose one method to configure the VPN Router.

4.2 Preparation

The following guide is designed to lead users through Web Configuration of G.shdsl.bis VPN Router in the easiest and quickest way possible. Please follow the instructions carefully.

- Step 1. Connect the Ethernet cable to a LAN port.(Note: The VPN Router supports auto-MDIX switching hub so both straight through and cross-over Ethernet cables can be used.)
- Step 2. Connect the WAN cable to the VPN Router over adapter or screws.
- Step 3. Connect power over screws.
- Step 4. Turn on the PC or NB, which is used for configuration of the VPN Router.

To avoid possible damage to the VPN Router, DO NOT turn on this device before hardware installation.

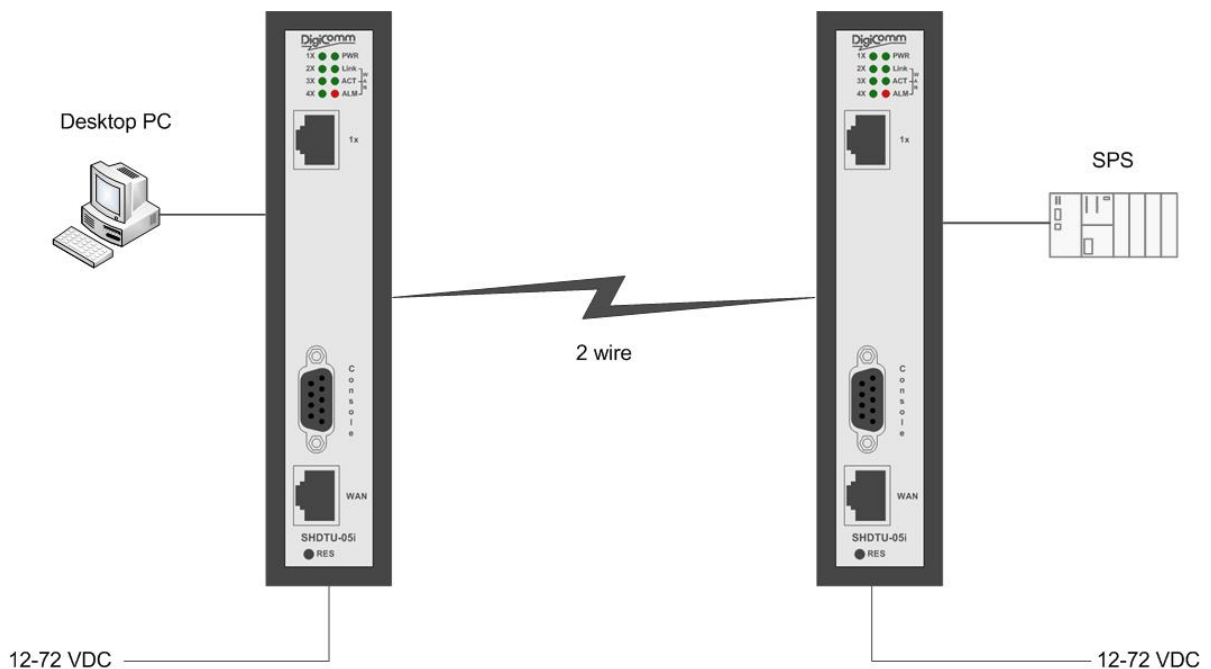

Connection with VPN Router

4.3 Web configuration (HTTP / HTTPS)

Make sure the Ethernet Adapter has been installed in PC or NB used for the configuration of the modem. TCP/IP protocol is necessary for web configuration, so please check the TCP/IP protocol whether it has been installed.

The VPN Router provides a browser interface that allows you to configure and manage this device. After you set up your IP address for the VPN Router, you can access the VPN Router's Web interface applications directly in your browser by entering the IP address of the VPN Router. You can then use your Web browser to list and manage configuration parameters from PC.

Web Configuration requires Internet Explorer 7.0 or later or equivalent and later versions. The recommended screen resolution is 1024 by 768 pixels.

4.3.1 Login via Web Browser

This section introduces the configuration and functions of the web-based management. It is an HTML-based management interface that allows users to setup and manage AddSecure SHDTU-05is VPN routers. This configuration system offers all monitoring and management features which allow users to access VPN routers from anywhere on the network with a standard browser, such as, Internet Explorer or Firefox.

- Step 1. User can use any common browsers, such as, Internet Explorer, on your computer to connect the VPN Router. Then, please type "http://192.168.0.1" for Master or http://192.168.0.2 for Slave in the address bar of the browser.
- Step 2. The default IP address and sub net-mask of the management port of VPN Router are "192.168.0.1" and "255.255.255.0".
- Step 3. Key in
- User name: "root"
Password: "root"
- then, click on "Login" button to login the web configuration.

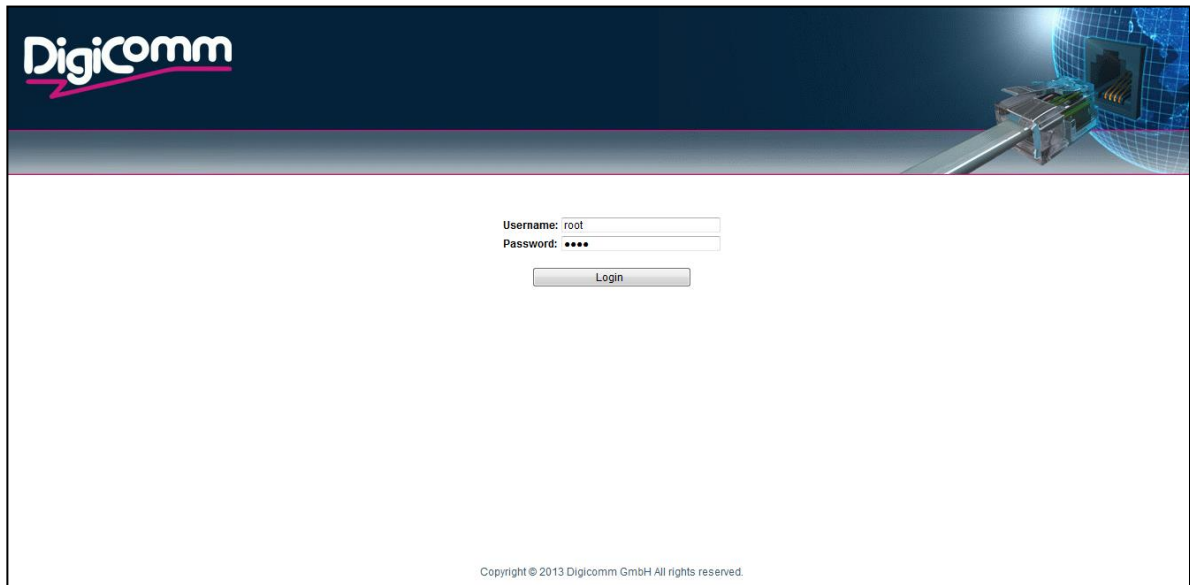

- Note: Both the default user name and password are “root”. It is suggested to change the user name and the password for security reason.
- Note: For safety purpose, the password will be prompt as star symbol.
- Note: Once you change the user name and password, please login with the new user name and password in the next login process.

4.4 Serial Console configuration

The console port is a RJ-45 connector that enables a connection to a PC for monitoring and configuring the VPN Router. Use the supplied serial cable with a female DB-9 connector to serial port of PC and RJ-45 module jack connector to VPN Router's console port. Start your terminal access program by terminal emulation program or Hyper Terminal and configure its communication parameters to match the following

default characteristics of the console port:

Parameter	Value
Baud Rate	115200
Data Bits	8
Parity Check	None
Stop Bits	1
Flow Control	None

It will ask for user name and password in order to remote login when using telnet, please use "root" for username and "root" for password.

```
### module <dhcp> init
### module <route> init
### module <rip> init
### module <qos> init
### module <snmp> init
### module <web> init
### module <ssh> init
### module <telnet> init
### module <upnp> init
### module <tr069> init
### module <ipsec> init
### module <l2tp> init
### module <pptp> init
### module <ppp> init
### module <shdslbis> init
### module <igmp> init
### module <ddns> init
### module <gsm> init

Welcome to VPN Router Configuration Tool
UserName : root
Password : ****
VPN#
```

4.5 Telnet / SSH configuration

The VPN Router also supports telnet or SSH for remote management. Please make sure the correct Ethernet cable connected to the LAN ports of device to your computer. The LAN indicator on the front panel shall light on if a correct cable is used. Start your telnet client with a command window or VT100 terminal emulation by key in "192.168.0.1" (Master) or "192.168.0.2" (Slave), which is the management IP address of SHDTU-05is VPN router, and wait for the login page to prompt up. Then, key in the user name and the password once the login page shows. The login page is shown as the following screen (The default user name and password are "root" and "root".)

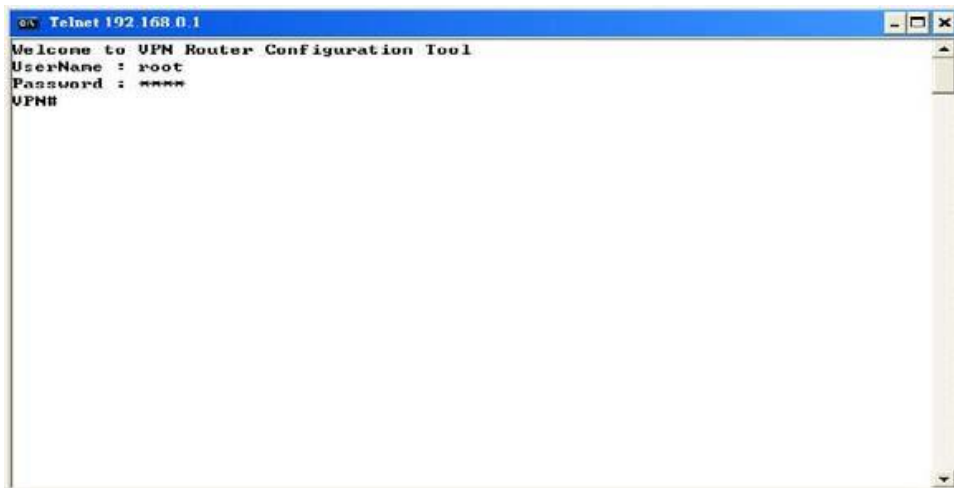

The default Telnet function is disabled. Therefore, before using this Telnet function, please enable Telnet with using Web management.